

What is HEPCLUDEX?

HEPCLUDEX (bulevirtide-gmod) is a prescription medicine used to treat chronic (long-lasting) hepatitis delta virus (HDV) infection in adults without cirrhosis or with compensated cirrhosis.

It is not known if HEPCLUDEX is safe and effective in children under 18 years of age.

IMPORTANT SAFETY INFORMATION

What is the most important information I should know about HEPCLUDEX?

HEPCLUDEX may cause serious side effects, including: Worsening of hepatitis delta virus (HDV) and hepatitis B virus (HBV) infection. Your HDV or HBV infection may get worse (flare-up) if you stop taking HEPCLUDEX, especially if you have cirrhosis. A "flare-up" is when your HDV or HBV infection suddenly returns in a worse way than before.

Do not stop taking HEPCLUDEX without first talking to your healthcare provider, as they will need to monitor health regularly to check your liver.

Severe allergic reactions (anaphylaxis). Stop taking HEPCLUDEX and call your healthcare provider or emergency medical help right away if you develop any of the following signs or symptoms: trouble swallowing or breathing, swelling of the mouth, lips, tongue or face, throat tightness, dizziness or fainting, severe rash, hives or itching, stomach area pain, nausea, diarrhea, or vomiting.

Please see additional Important Safety Information throughout and the [Patient Prescribing Information for HEPCLUDEX](#), including Important Warnings and Instructions for Use.



HEPCLUDEX[®]
bulevirtide-gmod 8.5mg for injection

INJECTION GUIDE

Your Step-By-Step Instructions for Taking HEPCLUDEX

Starting a treatment can bring a lot of questions. Use this resource to help you answer one of the most important ones: How to give yourself the daily HEPCLUDEX injection.

Click here to [watch a video](#) of how to mix and inject HEPCLUDEX.



PART 1 Getting Ready for Your HEPCLUDEX Injection

IMPORTANT SAFETY INFORMATION (CONT.)

What are the other possible side effects of HEPCLUDEX?

The most common side effects of HEPCLUDEX are injection site reactions (including infection, redness, itching, swelling, bruising, rash, and pain at the injection site), headache, stomach area pain, feeling tired, and itchy skin. These are not all the possible side effects of HEPCLUDEX. Tell your healthcare provider if you have any side effects that bother you or don't go away.

What is needed



HEPCLUDEX Vial



Sterile Water for Injection Vial

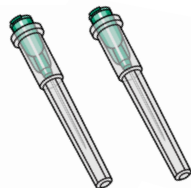

2 Sterile Transfer Needles

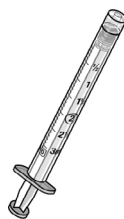

Sterile Syringe

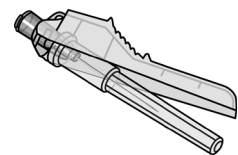

Sterile Injection Needle with Safety Shield

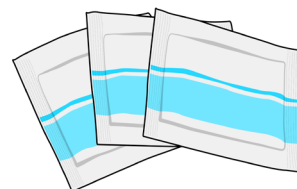

Alcohol swabs

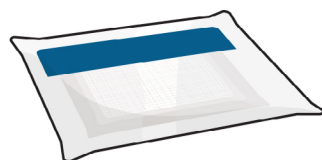

Cotton ball or gauze



Sharps disposal container

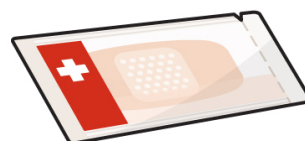

Adhesive bandage

Supplies from the pharmacy may look different than the ones pictured above.

Part 1: Getting ready for the injection



Gather all supplies and place them on a clean, flat surface with enough room for everything needed:

- 1 HEPCLUDEX Vial
- 2 Sterile Transfer Needles
- 1 Sterile Water for Injection Vial
- 1 Sterile Syringe
- 1 Sterile Injection Needle with Safety Shield

Additional supplies needed (may be provided by pharmacy):

- 1 sharps disposal container
- 1 adhesive bandage
- 1 cotton ball or gauze
- 3 alcohol swabs

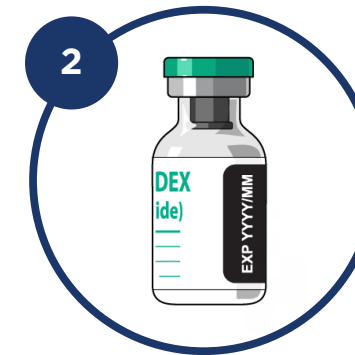

Inspect the HEPCLUDEX Vial and supplies.

- Check the expiration dates on the HEPCLUDEX Vial and on the supplies for mixing and injecting HEPCLUDEX
- **Do not** use if any of the expiration dates have passed
- Check the HEPCLUDEX Vial and supplies packaging for damage

IMPORTANT: Do not use if:

- Expiration date has passed
- Packaging has been dropped or is damaged



Wash your hands well.

- Use soap and water
- Dry hands using a clean towel

Remember that after washing your hands, you should not touch anything except the HEPCLUDEX Vial, the injection supplies, and the area around the injection site.

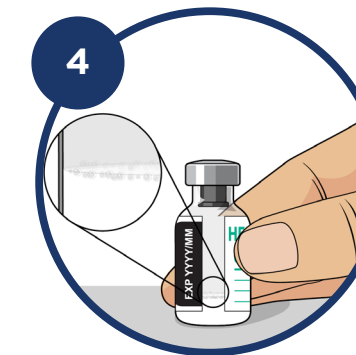

Inspect your supplies.

- Check the HEPCLUDEX Vial, Sterile Water for Injection Vial, Transfer Needles, Syringe, and Injection Needle (supplies) for damage
- Check the powder or cake in the HEPCLUDEX Vial, which should be a white to off-white color

IMPORTANT: Do not use if:

- Vials or supplies look damaged or have dropped onto a hard surface
- Vial caps are missing, loose, or damaged
- Powder or cake in the HEPCLUDEX Vial is discolored

Please see additional Important Safety Information throughout and the [Patient Prescribing Information](#) for HEPCLUDEX, including Important Warnings and Instructions for Use.



PART 2 Preparing HEPCLUDEX

IMPORTANT SAFETY INFORMATION (CONT.)

What should I tell my healthcare provider before taking HEPCLUDEX?

All your medical conditions, including: If you are pregnant or plan to become pregnant. It is not known if HEPCLUDEX can harm your unborn baby. Tell your healthcare provider if you become pregnant during treatment with HEPCLUDEX.

If you are breastfeeding or plan to breastfeed. It is not known if HEPCLUDEX can pass into your breast milk. Talk to your healthcare provider about the best way to feed your baby during treatment with HEPCLUDEX.

All the medicines you take, including prescription and over-the-counter medicines, vitamins, and herbal supplements. Do not start a new medicine without telling your healthcare provider.

What is needed

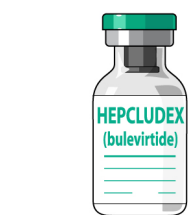

HEPCLUDEX Vial



Sterile Water for Injection Vial

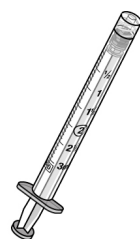

Sterile Syringe



Sterile Transfer Needle

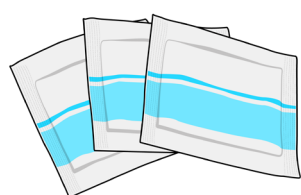

Alcohol swabs

Supplies from the pharmacy may look different than the ones pictured above.

Part 2: Preparing the materials

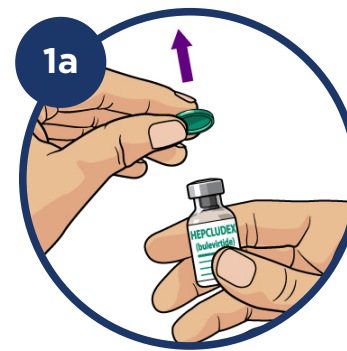

- Remove the cap from the HEPCLUDEX Vial

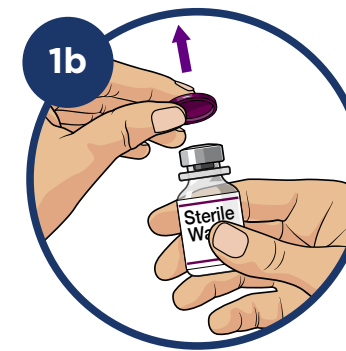

- Remove the cap from the Sterile Water for Injection Vial

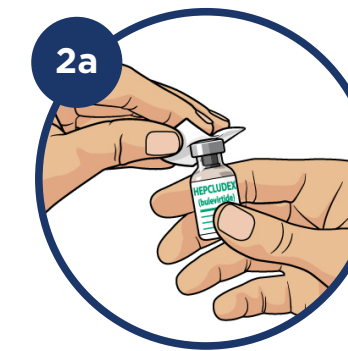

- Clean the rubber stopper of the HEPCLUDEX Vial with an alcohol swab

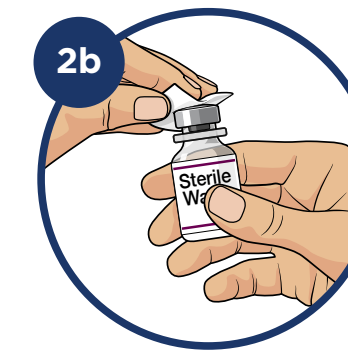

- With a different alcohol swab, clean the rubber stopper of the Sterile Water for Injection Vial

IMPORTANT: Do not touch the stoppers after they have been cleaned.

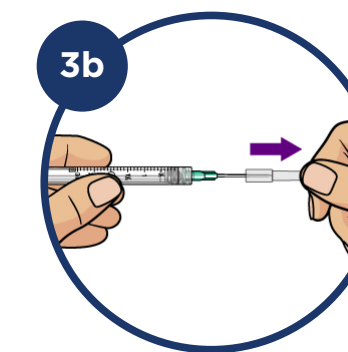
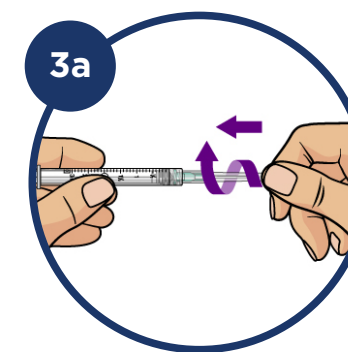

Remove a Sterile Transfer Needle and Sterile Syringe from their packaging and attach the Transfer Needle by turning it clockwise (to the right) onto the Syringe until it is fully connected.

- Hold both the Syringe and Transfer Needle firmly when attaching
- To remove the cap from the Transfer Needle, pull it straight off and keep the cap for later use

IMPORTANT: Do not use the Transfer Needle if it is bent or appears damaged.

Please see additional Important Safety Information throughout and the [Patient Prescribing Information](#) for HEPCLUDEX, including Important Warnings and Instructions for Use.



PART 3 Mixing HEPCLUDEX

IMPORTANT SAFETY INFORMATION (CONT.)

How should I take HEPCLUDEX?

See the detailed Instructions for Use that is provided with HEPCLUDEX for information on how to prepare and inject HEPCLUDEX.

- HEPCLUDEX is given as an injection under your skin (subcutaneous) by you or a caregiver.
- Make sure you or your caregiver are trained by your healthcare provider on how to prepare and inject HEPCLUDEX before you take it for the first time.
- Do not reuse the vials, syringe, needles, or any remaining Sterile Water for Injection.
- Take HEPCLUDEX exactly as your healthcare provider tells you to take it.
- Take HEPCLUDEX 1 time each day.

You are encouraged to report negative side effects of prescription drugs to the FDA. Visit www.fda.gov/medwatch or call 1-800-FDA-1088.

What is needed



HEPCLUDEX Vial



Sterile Water for Injection Vial

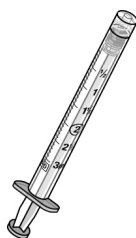

Sterile Syringe



2 Sterile Transfer Needles



Sharps disposal container

Supplies from the pharmacy may look different than the ones pictured above.

Part 3a: Preparing and filling your Syringe with sterile water

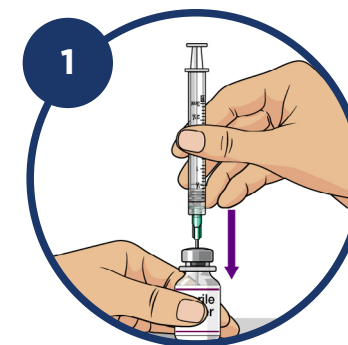

- 1
- Hold the Sterile Water for Injection on a flat surface
 - Insert the Sterile Transfer Needle all the way into the Sterile Water for Injection Vial by pushing it straight through the center of the rubber stopper

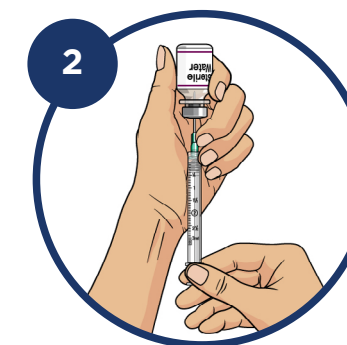

- 2
- Turn the Sterile Water for Injection and Sterile Syringe upside down so the vial is pointing upwards.
- Be sure that the tip of the Transfer Needle is in the liquid

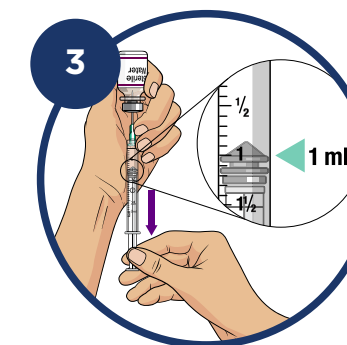

- 3
- With one hand, keep the Syringe and Transfer Needle in place
 - With the other hand, carefully **pull the plunger down until the top rim of the plunger lines up with the 1 mL marking** on the Syringe
 - If you see large air gaps in the Syringe, push the plunger all the way up and repeat steps 2 and 3 on this page

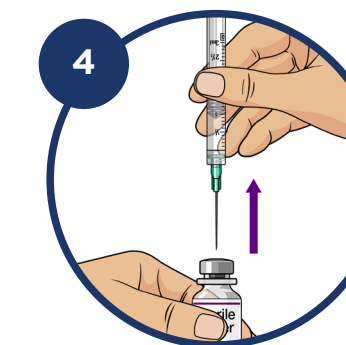

- 4
- Hold the plunger in place and turn the Sterile Water for Injection Vial and Syringe upright
 - Hold the vial on a flat surface
 - Remove the Syringe with 1 mL of sterile water and the Transfer Needle attached from the Sterile Water for Injection Vial by pulling it straight up by the Syringe body
 - Extra water may be left in the vial
 - Dispose of the Sterile Water for Injection Vial in your household trash

IMPORTANT: Do not touch the Transfer Needle or let it touch any surface.*

*Please see "Important Information You Need to Know Before Injecting HEPCLUDEX" within the Instructions for Use as needed for additional information.

Please see additional Important Safety Information throughout and the [Patient Prescribing Information](#) for HEPCLUDEX, including Important Warnings and Instructions for Use.



PART 3 Mixing HEPCLUDEX (cont.)

What is HEPCLUDEX?

HEPCLUDEX (bulevirtide-gmod) is a prescription medicine used to treat chronic (long-lasting) hepatitis delta virus (HDV) infection in adults without cirrhosis or with compensated cirrhosis.

It is not known if HEPCLUDEX is safe and effective in children under 18 years of age.

Part 3b: Transferring sterile water to the HEPCLUDEX Vial

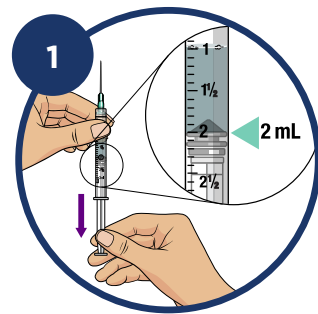

Pull plunger to the 2 mL marking on the Syringe to add air to the Sterile Syringe.
IMPORTANT: Do not pull the plunger out of the Syringe.

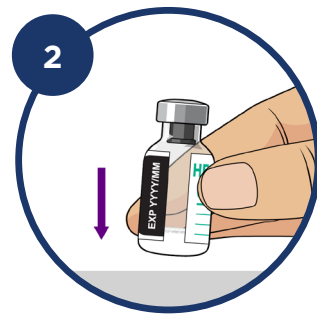

Get the HEPCLUDEX Vial and hold it upright on a flat surface.

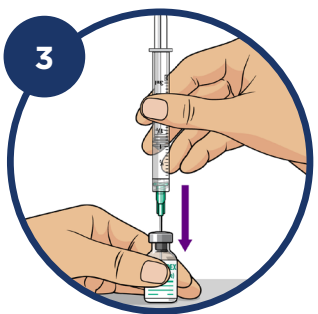

Insert the Transfer Needle all the way into the HEPCLUDEX Vial by pushing it straight through the center of the rubber stopper.

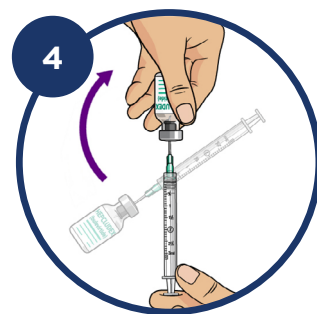

Turn the HEPCLUDEX Vial and Syringe upside down so the vial is pointing upwards.

- **Slowly** push the plunger all the way up until the Syringe is empty
- Pushing the plunger all the way up fills the HEPCLUDEX Vial with air and the Sterile Water for Injection

Part 3c: Mixing sterile water with HEPCLUDEX powder

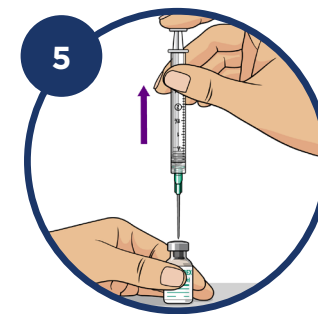

Keeping the plunger in place, turn the HEPCLUDEX Vial and Syringe upright and hold the vial on a flat surface.

- Remove the empty Syringe with the Transfer Needle attached from the HEPCLUDEX Vial by pulling it straight up

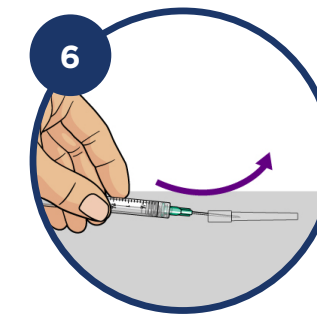

Using one hand, slide the Transfer Needle into its cap and scoop upwards to cover the needle.

- When the Transfer Needle is covered, carefully push the cap toward the Syringe to fully attach it
- Keep the Syringe with Transfer Needle attached for later use

IMPORTANT: Do not touch the Transfer Needle.*



Slowly swirl the HEPCLUDEX Vial for a few seconds to mix the powder with the Sterile Water for Injection.

- If there is powder stuck to the vial wall or rubber stopper, continue to swirl the vial slowly until it is removed

IMPORTANT: Do not shake the vial.

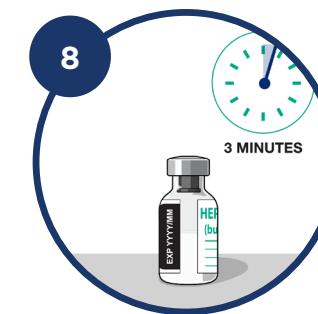

Place the HEPCLUDEX Vial upright on a flat surface.

- Wait for the powder to fully dissolve. This may take up to 3 minutes



Check that the powder is fully dissolved. The medicine should look clear without any clumps or particles. It is normal to see foam in the medicine.

- **Do not** use the medicine if you see particles or clumps that have not completely dissolved, including powder stuck to the vial wall or rubber stopper
- Repeat steps 7 and 8 if the powder is not fully dissolved

*Please see "Important Information You Need to Know Before Injecting HEPCLUDEX" within the Instructions for Use as needed for additional information.

Please see additional Important Safety Information throughout and the [Patient Prescribing Information](#) for HEPCLUDEX, including Important Warnings and Instructions for Use.



Part 3d: Filling the Syringe with HEPCLUDEX

PART 3 Mixing HEPCLUDEX (cont.)

IMPORTANT SAFETY INFORMATION

What is the most important information I should know about HEPCLUDEX?

HEPCLUDEX may cause serious side effects, including:

Worsening of hepatitis delta virus (HDV) and hepatitis B virus (HBV) infection. Your HDV or HBV infection may get worse (flare-up) if you stop taking HEPCLUDEX, especially if you have cirrhosis. A "flare-up" is when your HDV or HBV infection suddenly returns in a worse way than before.

Do not stop taking HEPCLUDEX without first talking to your healthcare provider, as they will need to monitor health regularly to check your liver.

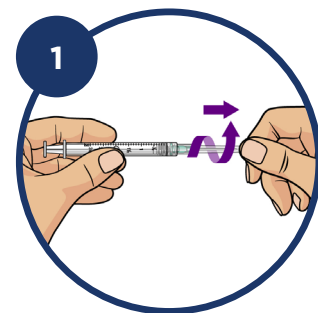

Hold the Sterile Syringe firmly. Turn the capped Sterile Transfer Needle to the left (counterclockwise) to remove it from the Syringe.

- Dispose of the Transfer Needle in the sharps disposal container
- Place the Syringe flat on a clean surface

IMPORTANT: Do not touch the Syringe tip or allow it to touch any surface.*

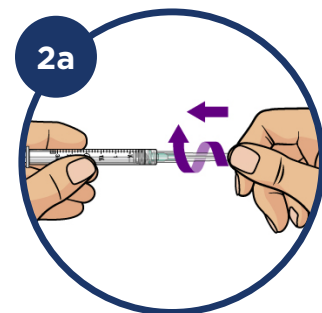

Remove the second Transfer Needle from its packaging. Hold the Syringe and the Transfer Needle firmly.

- Turn the Transfer Needle to the right (clockwise) onto the Syringe until it is fully connected
- Remove the needle cap from the Transfer Needle by pulling it straight off

• **Keep the needle cap for later use**

IMPORTANT: Do not use the Transfer Needle if it is bent or appears damaged.

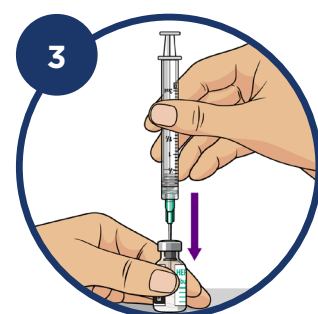
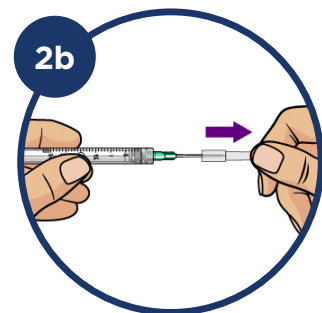

Hold the mixed HEPCLUDEX Vial on a flat surface.

- Insert the Transfer Needle all the way into the HEPCLUDEX Vial by pushing it straight through the center of the rubber stopper
- Check the plunger is pushed all the way down. If the plunger has risen, push the plunger all the way down
- All air should be pushed out of the Syringe
- Keep the plunger fully pushed down

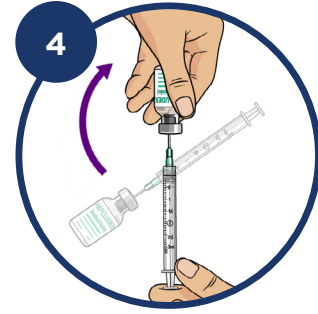

While pushing down on the plunger, turn the HEPCLUDEX Vial and Syringe so that the vial is pointing upwards.

- **Do not** let go of the plunger
- If you let go of the plunger before the vial is pointing upwards, turn the vial so it is facing downwards again and repeat step 3

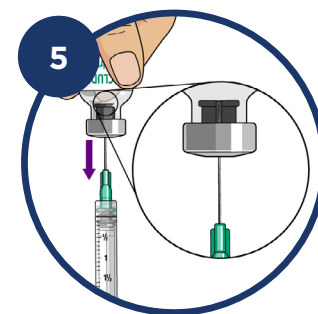

Hold the HEPCLUDEX Vial pointing upwards. Pull the Transfer Needle down until the needle tip is near the bottom of the rubber stopper in the vial.

- Check the position through the gap in the rubber stopper

IMPORTANT: Do not completely remove the needle from the vial.

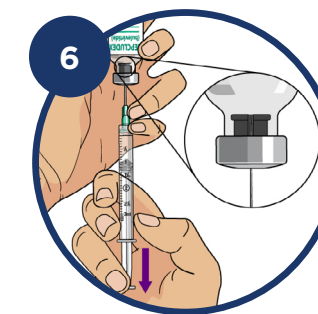

Keeping the Transfer Needle tip in place inside the HEPCLUDEX Vial, carefully pull the plunger until **all the medicine** is removed from the HEPCLUDEX Vial.

- Hold the plunger in place to keep all the medicine in the Syringe
- An air gap above the medicine is normal at this step and will be removed before injection. Small air bubbles in the medicine are normal
- Leftover foam in the vial is normal

IMPORTANT: Do not pull the plunger out of the Syringe.

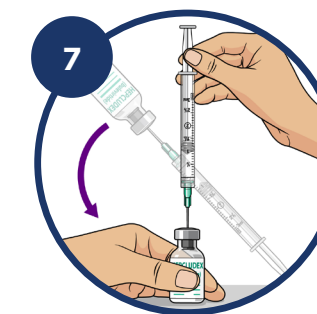

Before continuing, check that all the liquid medicine is removed from the HEPCLUDEX Vial.

- Hold the plunger in place and turn the HEPCLUDEX Vial and Syringe upright
- Hold the vial on a flat surface

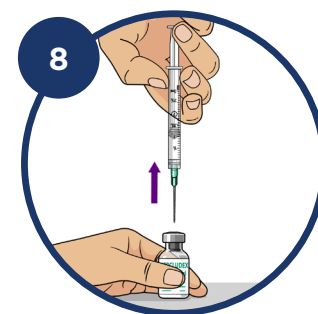

While holding the Syringe body and plunger in place, remove the Syringe with the Transfer Needle attached from the HEPCLUDEX Vial.

- **Do not** push on the plunger until ready to inject
- Pushing the plunger will cause medicine to come out of the Syringe

Throw away the HEPCLUDEX Vial into the household trash.

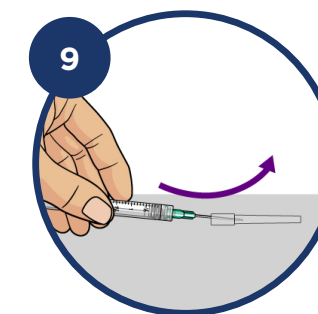

Using one hand, slide the Transfer Needle into its cap and scoop upwards to cover the needle.

- When the Transfer Needle is covered, carefully push the needle cap towards the Syringe to fully attach it

IMPORTANT: Do not touch the Transfer Needle.*

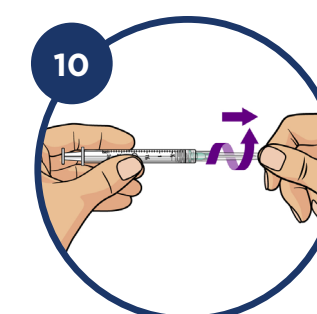

Hold the Syringe firmly. Turn the capped Transfer Needle to the left (counterclockwise) to remove it from the Syringe.

- Dispose of the Transfer Needle in the sharps disposal container
- Place the Syringe on a clean surface

IMPORTANT: Do not touch the Syringe tip or allow it to touch any surface.*

*Please see "Important Information You Need to Know Before Injecting HEPCLUDEX" within the Instructions for Use as needed for additional information.

*Please see "Important Information You Need to Know Before Injecting HEPCLUDEX" within the Instructions for Use as needed for additional information.

Please see additional Important Safety Information throughout and the [Patient Prescribing Information](#) for HEPCLUDEX, including Important Warnings and Instructions for Use.



PART 4 Injecting HEPCLUDEX

IMPORTANT SAFETY INFORMATION (CONT.)

What is the most important information I should know about HEPCLUDEX? (cont.)

Severe allergic reactions (anaphylaxis). Stop taking HEPCLUDEX and call your healthcare provider or emergency medical help right away if you develop any of the following signs or symptoms: trouble swallowing or breathing, swelling of the mouth, lips, tongue or face, throat tightness, dizziness or fainting, severe rash, hives or itching, stomach area pain, nausea, diarrhea, or vomiting.

What is needed

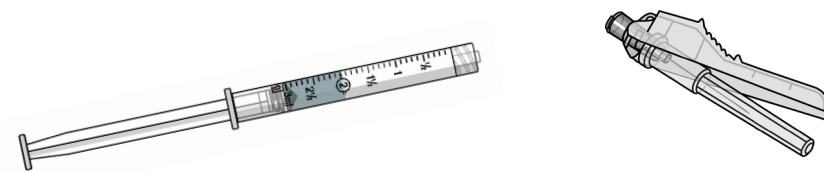

Syringe with mixed medicine

Sterile Injection Needle with Safety Shield

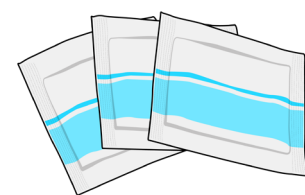

Alcohol swabs

Supplies from the pharmacy may look different than the ones pictured above.

Part 4a: Preparing your injection

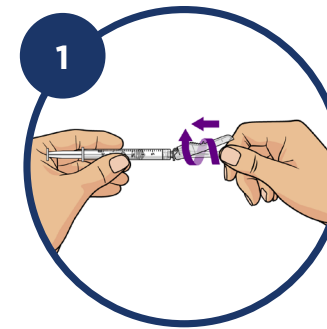

Remove the Injection Needle from the packaging.

- Hold the Syringe firmly
- Turn the Injection Needle to the right (clockwise) onto the Syringe tip until it is fully connected
- Place the Syringe with the Injection Needle attached on a flat surface

IMPORTANT: Do not remove the needle cap or push the plunger until you are ready to inject the medicine.

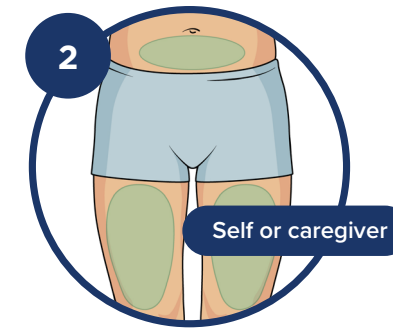

Rotate your injection sites.

- To inject yourself, choose a site on your lower abdomen (stomach) or upper thighs
- If someone else is injecting the medicine for you, they can also choose the back of the upper arms

IMPORTANT: Remember to change injection sites regularly. Do not inject into the same site on consecutive days or in the following areas: moles; scars; bruises; tattoos; into areas where the skin is red, hard, tender, or injured; or inside a 1-inch area around the belly button (navel).

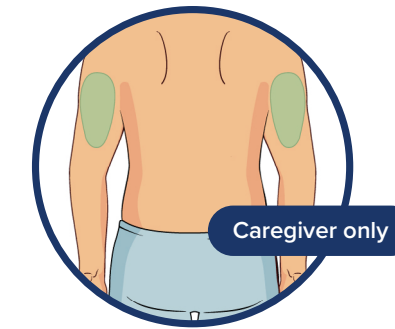

Clean the injection site with a new alcohol swab.

- Allow the skin to air dry

IMPORTANT: Do not touch or blow on the injection site after it has been cleaned.

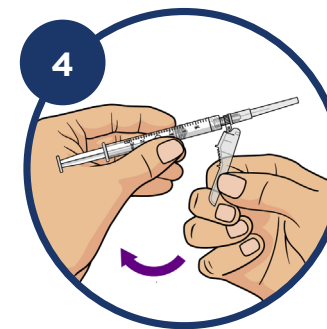

Now prepare the Syringe for injection. Hold the Syringe firmly and then gently pull back the Injection Needle Safety Shield.

IMPORTANT: Do not remove the needle Safety Shield from the Injection Needle.

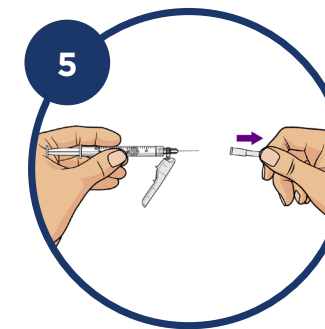

Carefully pull off the Injection Needle cap and throw it away into the household trash.

IMPORTANT: Do not touch the needle or allow it to touch any other surface.* Also, **do not** recap the needle.

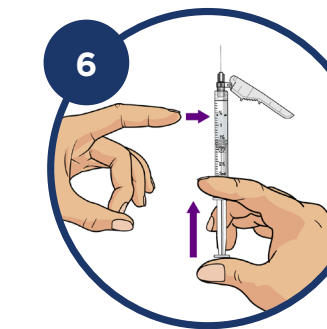

Make sure the Injection Needle is pointing up and the air gap in the Syringe is at the top.

- If there are large air bubbles, tap the Syringe with your finger until the air bubbles move to the top

IMPORTANT: Do not touch the needle or allow it to touch any other surface.

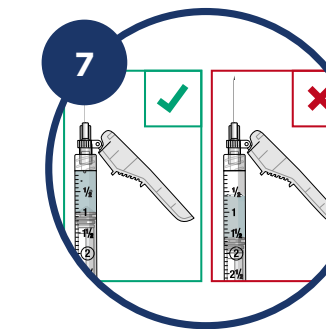

If there is a large air gap, carefully push the plunger up to remove most of the air gap at the top.

- Small air bubbles are normal and do not need to be removed
- It is okay for a few drops of medicine to come out of the Syringe

Do not touch the Injection Needle or allow it to touch any other surface.*

*Please see "Important Information You Need to Know Before Injecting HEPCLUDEX" within the Instructions for Use as needed for additional information.

Please see additional Important Safety Information throughout and the [Patient Prescribing Information](#) for HEPCLUDEX, including Important Warnings and Instructions for Use.



PART 4 Injecting HEPCLUDEX (cont.)

IMPORTANT SAFETY INFORMATION (CONT.)

What are the other possible side effects of HEPCLUDEX?

The most common side effects of HEPCLUDEX are injection site reactions (including infection, redness, itching, swelling, bruising, rash, and pain at the injection site), headache, stomach area pain, feeling tired, and itchy skin. These are not all the possible side effects of HEPCLUDEX. Tell your healthcare provider if you have any side effects that bother you or don't go away.

You are encouraged to report negative side effects of prescription drugs to the FDA. Visit www.fda.gov/medwatch or call 1-800-FDA-1088.

What is needed

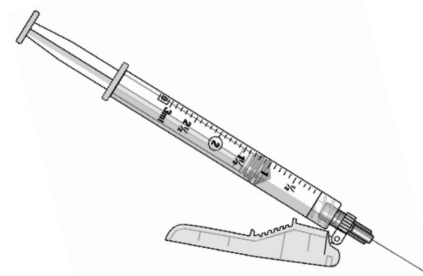

Syringe with mixed medicine and the Sterile Injection Needle with Safety Shield

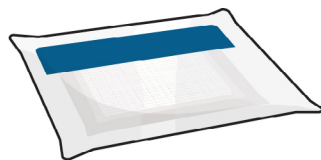

Cotton ball or gauze



Sharps disposal container

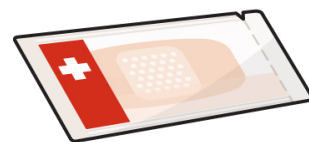

Adhesive bandage

Supplies from the pharmacy may look different than the ones pictured above.

Part 4b: Procedure for injecting HEPCLUDEX

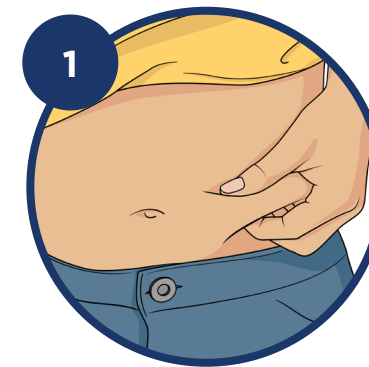

While holding the Syringe, use your other hand to pinch the cleaned injection site.

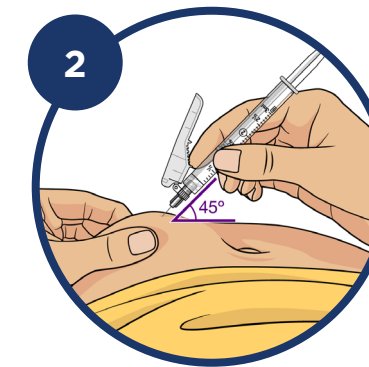

- Insert the Injection Needle all the way into the pinched skin at a **45 to 90 degree angle**
- Slowly push down on the plunger until all of the medicine is injected into the skin
- Carefully pull out the needle at the same angle as you inserted it

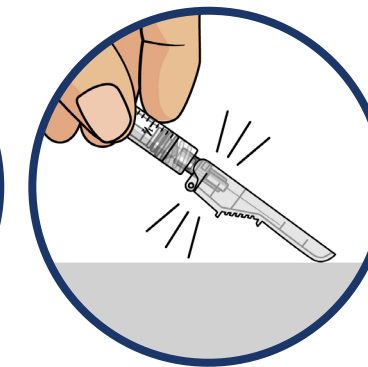
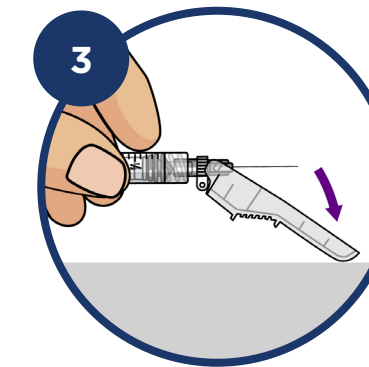

- Right after the injection, place the Injection Needle Safety Shield on the work surface
 - Press the needle toward the safety shield to cover the needle and lock the Safety Shield
- IMPORTANT: Do not touch or remove the Injection Needle from the Syringe.***

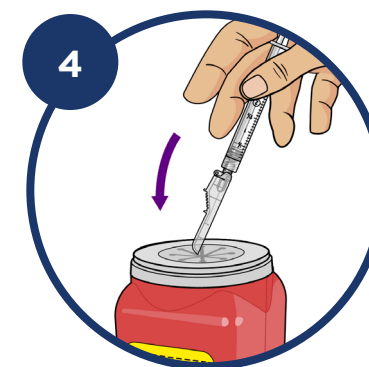

Throw away (dispose of) the used Syringe with Injection Needle attached in the sharps disposal container.

- Dispose of any remaining waste in the household trash

Local regulations may vary for disposal of injection medical waste.



If there is bleeding at the injection site, gently press a clean cotton ball or gauze over the injection site for several seconds.

- Cover the injection site with an adhesive bandage if needed

IMPORTANT: Do not rub the injection site.



Following the injection, you should record the details in a journal or diary.

- Recording details about your injection is an important step in adjusting to your treatment
- You may want to record any questions about your treatment so you can discuss them with your healthcare provider during your next visit

*Please see "Important Information You Need to Know Before Injecting HEPCLUDEX" within the Instructions for Use as needed for additional information.

Please see additional Important Safety Information throughout and the [Patient Prescribing Information](#) for HEPCLUDEX, including Important Warnings and Instructions for Use.



This brochure is intended for use by patients prescribed HEPCLUDEX.

HEPCLUDEX, the HEPCLUDEX Logo, GILEAD, and the GILEAD Logo are trademarks of Gilead Sciences, Inc., or its related companies.

©2026 Gilead Sciences, Inc. All rights reserved. US-HPXC-0062 05/26